

20swg/1.0mm Flat 'S' Cleat Rollformer

Manufactured by W. Neal Services Ltd

W. NEAL SERVICES LTD
 29 Purdeys Way
 Purdeys Industrial Estate
 Rochford
 Essex
 SS4 1ND
 ENGLAND

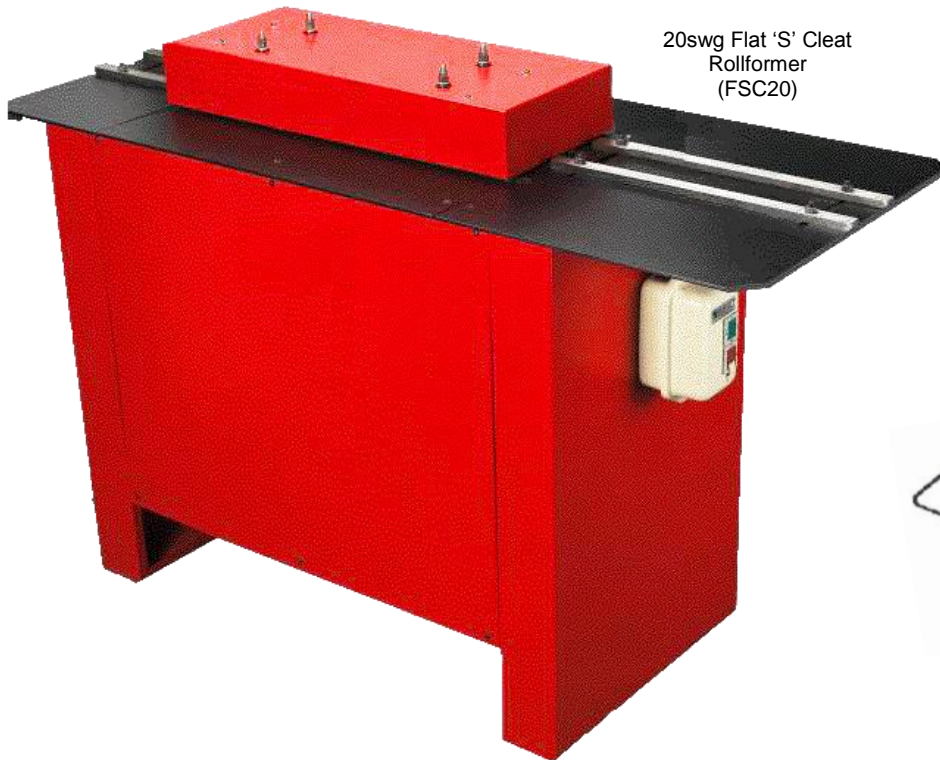



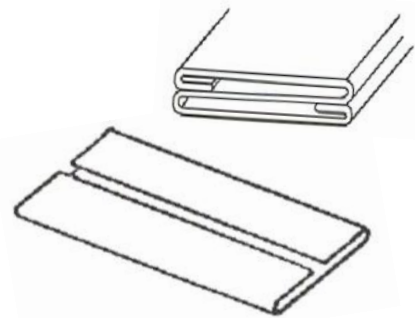







20swg Flat 'S' Cleat
 Rollformer
 (FSC20)



WNS 20swg (1.0mm) 'S' CLEAT ROLLFORMERS are 9 station machines; they have flat 'S' cleat rolls built inboard with double extended shafts onto which many other rolls can be fitted. (See table below). The Rollformer is manufactured with all steel side plates. The shafts, forming rolls, gears and guide fences are all hardened and needle

CE

SPECIFICATIONS										
Auxiliary Rolls	'S' Cleat Rolls Fitted In-board Standard	Small Pittsburgh Lock *	Drive Cleat *	Double Seam*	Plain Seam*	Right Angle Flange*	Standing Seam*	3 in 1*	Safe Edge*	Closed Double Seam*
Sections										
Material Used	92mm	25mm	54mm	32mm	11mm	11mm	54mm	-	-	32mm
Max. Thickness	0.8mm	0.8mm	1.0mm	1.2mm	1.0mm	1.6mm	0.8mm	0.8mm	0.8mm	1.2mm
Seam Width	27mm	10mm	29mm	13mm	10mm	-	-	-	8-10mm	13mm
Flange Height	-	-	-	-	-	Max. 11mm	-	-	-	-
Seam Height	-	-	-	-	-	-	19mm	15mm	-	-
Model	Length	Width	Height	Weight	Motor	Speed				
FSC20	1650mm	615mm	1000mm	275Kg	2HP (1.5kw)	8m/min				

* Optional rolls can be fitted onto auxiliary shafts.

All capacities are based on the use of Rollforming quality Mild Steel. All dimensions and weights are approximate. Colours may vary. W. Neal Services Ltd reserves the right to alter any specifications. E&OE.